



# Assembly Instructions Sheet #SML2213

Tools Required: Flathead screwdriver, Phillips screwdriver, pliers, wirecutters, wire strippers, electrical tape, safety glasses.

Light Source: Medium Base 60W bulb Maximum.  
Estimated Assembly Time: 20-30 minutes.

Preparation: Identify and inspect all parts before beginning installation. Check package contents and diagrams below to be sure all parts are present. If any parts are missing or damaged, do not attempt to assemble, install, or operate the fixture. Contact customer service for replacement parts.

### Warnings and Cautions

Turn off electricity at circuit breaker or main fuse box before installation. Consult a licensed electrician if in doubt. These instructions are provided for your safety. It is very important you read them completely before installing the fixture. We strongly recommend that a licensed professional electrician perform the installation. Disconnected fixture from power source before replacing bulbs. Make sure bulbs are given sufficient time to cool before removal. Do not touch the bulb with bare hands use a cloth or glove.

### Package Contents

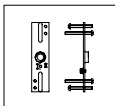

A Crossbar Assembly x1

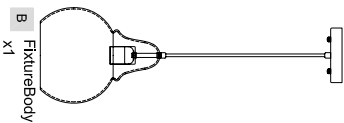

B Fixture Body x1

### STEP 1 Adjust Fixture Height

A. With a screwdriver, unlock the Set Screw on the coupling under side of the Ceiling Canopy. Pull the Wire In or out of the Ceiling Canopy to achieve your desired hanging height. Minimum hanging height should be 4" from bottom edge of the Socket to the top edge of the ceiling canopy. Once your desired hanging height is achieved, tighten the Set Screw on the Coupling to secure the Wire.

B. Move the Wire Clasp closed to hex nut inside of the ceiling canopy.

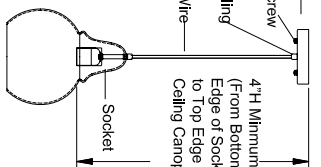

Figure 1

### STEP 2 Attach crossbar Assembly to Outlet Box

A. Attach the Crossbar Assembly, (A) to Outlet Box and secure by threading Outlet Box Screws (not supplied) into the Mounting Holes on the Outlet Box. Tighten until snug.

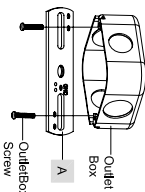

Figure 2

### STEP 3 Make Wire Connections

A. Use standard wire connectors (not included) to make all wire connections. Twist connectors until wires are tightly joined together. Wrap each connection with approved electrical tape and carefully stuff all the connected wires into the Outlet Box.

B. If the electrical wire is going to be cut short than provided, strip back the clear wire covering the 3 fixture wires as far as you need to. This will expose each fixture wire individually. Strip each end of 3 fixture wires.

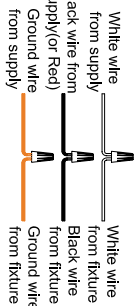

Figure 3

### STEP 4 Install Fixture Body

A. Carefully, tuck all wires into the outlet box and position the ceiling canopy (D) over the outlet box. Align the holes in the Ceiling Canopy (D) with the mounting screws, then attach the Ceiling Canopy (D) using the previously removed mounting balls. Hand tighten until snug.

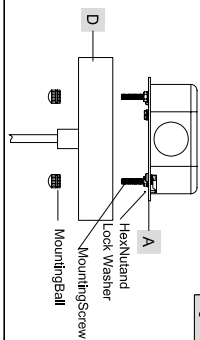

Figure 4

### CAUTION FOR BULB REPLACING

A. When replace bulb, turn off power and allow lamp to cool. For safety purpose, wear gloves and eye protection.  
B. If bulb is scratched or cracked, DO NOT use the lamp to avoid breakage during use or installation.  
C. Use only in fixtures rated for lamps wattage and voltage.  
D. Prevent the bulb from contacting liquid or combustible materials.

SML2213

Figure 5

### STEP 5 -Install Bulbs

A. Insert bulbs (B) onto sockets and push snugly into place.

**IMPORTANT:**  
Do not touch the bulb with bare hands use a cloth or glove.

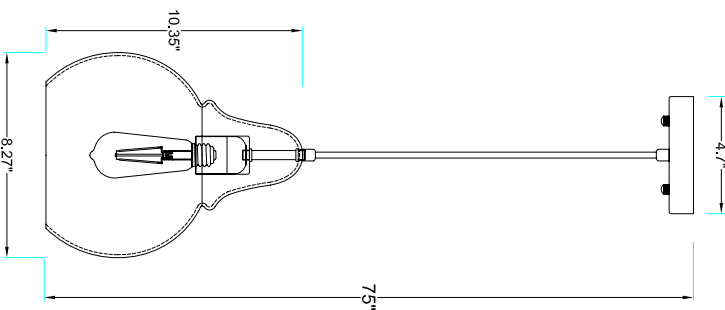
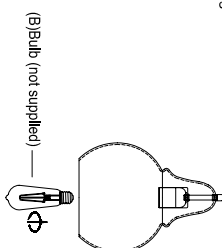

NOTE: ALL DIMENSIONS ARE ROUNDED UP TO THE NEAREST 1/4"